



ELECTRIC CHAIN HOIST

DMK SERIES



ELECTRIC CHAIN HOIST



DMK SERIES

DMK series, the most reliable and safe way to lift loads up to 4.000 kg.

The DMK electric hoists with self-braking conical motors, have always been synonymous with quality and reliability. Designed to meet the needs of the international market, they offer a wide range of uses, long-term reliability, safety guarantees during all operating phases and excellent value for money.

DMK hoists are also known for the quality of their components, the high technology used to machine mechanical parts, finishing and surface treatments.

The special water-repellent paintwork, applied with a completely enclosed electrostatic process, guarantees durability and constant top performance, including in particularly hostile environments.



MAX

4.000 KG

Quality and reliability
at your service



TROLLEYS

The electric chain hoist is generally used to lift un-guided loads, using a hook or handling accessories adequate for the purpose. When the hoist is combined with an electric or manual trolley, which runs on a beam, it ensures combined lifting and horizontal movement of the load.

The electric chain hoist and trolleys can be mounted overhead and fitted with monorails or be incorporated and become the completion of other lifting machines such jib cranes, bridge cranes. The electric chain hoist, positioned overhead or on the ground, can also be used in various fixed position configurations.



**POWERFUL
AND SAFE
TROLLEYS
AT YOUR
SERVICE**





DMK series electric chain hoists and electric trolleys are manufactured based on a modular component design, assembled together based on commercial needs, and make it possible to quickly and inexpensively create many standardised and special executions; in addition to the standard versions always available in the warehouse. Thanks to the extreme compactness of the basic components, i.e. the motor and gearbox, they are assembled together in a coaxial line, in order to ensure the maximum use of the hook run and minimum encumbrance of the hoist. The construction of all components is based on production processes that make it possible to create completely reliable and technically high-performing machines through economies of scale. The high quality level is guaranteed and controlled by the company quality system certified according to the standard EN ISO9001: 2008

THE ELECTRIC CHAIN HOIST RANGE

The DMK Range – Series, Capacities and Lifting Speed.

4 BASIC SIZES

DMK 1-2-3-4, for loads from 100 to 4,000 kg, in FEM (ISO) service units 1Bm (M3) - 1Am (M4) - 2m (M5).

ONE LIFTING SPEED

Created with 1 polarity motor:

- ▶ 4, 6.3, 8 or 16 m/min 1 fall for 1 chain fall hoists
- ▶ 3.2 or 4 m/min 2 fall for 2 chain fall hoists

TWO LIFTING SPEEDS

Created with pole changing motor:

- ▶ 4/1.2, 6.3/2.1 or 8/2.5 m/min for 1 chain fall hoists
- ▶ 2.5/0.8 or 3.2/1 m/min. for 2 chain fall hoists

STANDARD HOOK PATH: up to 12 m

- ▶ over 12 m upon request

PROTECTION AND INSULATION OF ELECTRICAL PARTS

Self-braking In the lifting and travelling motors;

- ▶ IP55 protection – “F” insulation class
- ▶ DMK 1-2-3-4 brake: IP23
- ▶ Limit switch: IP65 minimum protection – 500 V maximum insulation voltage
- ▶ Cables: IEC 20/22 II 450/750 V maximum insulation voltage
- ▶ Non-standard protections and insulations are available upon request.

ELECTRICAL POWER SUPPLY

- ▶ Standard DMK electric chain hoists are designed to be powered with AC current with the following voltage:
 - three phase of 400 V - 50Hz. according to IEC 38-1
 - single phase of 230 V +/- 5% - 50 Hz. (for DMK 1-2-3 hoists at one speed and capacity up to 800 kg)
- ▶ Non-standard voltages and frequencies are available upon request.

NOMINAL USE CONDITIONS

IN THE STANDARD EXECUTION:

- ▶ Operating temperature: minimum -10°C; maximum +40°C
- ▶ Maximum relative humidity: 80%
- ▶ Maximum altitude 1000 m above sea level
- ▶ The machine must be installed indoors, in a well-ventilated place, free from corrosive fumes (acid fumes, saline mist, etc.)

NOISE LEVEL

- ▶ The sound pressure level emitted by the hoist when fully loaded is always less than 85 dB (A). The incidence of environmental characteristics such as the transmission of sound through metallic structures, reflection caused by combined machines and walls, is not included in the indicated level.



FIXED EXECUTION:

eyebolt suspension or hook suspension (upon request).



**TROLLEY EXECUTION
HAND-PUSHED:**

horizontal movement by manually pushing the load.

ELECTRIC: movement is motorised (one or two speeds) and controlled directly from the hoist push button pendant.

CHAIN: horizontal movement by chain controlled by the operator who controls the trolley wheels.



**LOW HEADROOM
EXECUTION:**

to use the maximum hook run, the hoist is fitted with a chain return system mounted on the trolley (electric or hand-push) with compact dimensions.



**"CLIMBING"
EXECUTION:**

the climbing execution makes it possible to reach the installation point with just the hook and chain, without having to lift the entire weight of the hoist. It is particularly suitable for machinery installations industry, or when frequent hoist assembly/disassembly operations are required at a greater height.

THE ELECTRIC CHAIN HOIST RANGE

FIXED EXECUTION,
ELECTRIC AND HAND-PUSHED
TROLLEY EXECUTION,
LOW HEADROOM EXECUTION AND
"CLIMBING" EXECUTION



THE HOIST IN DETAIL

DESIGN AND CONSTRUCTION

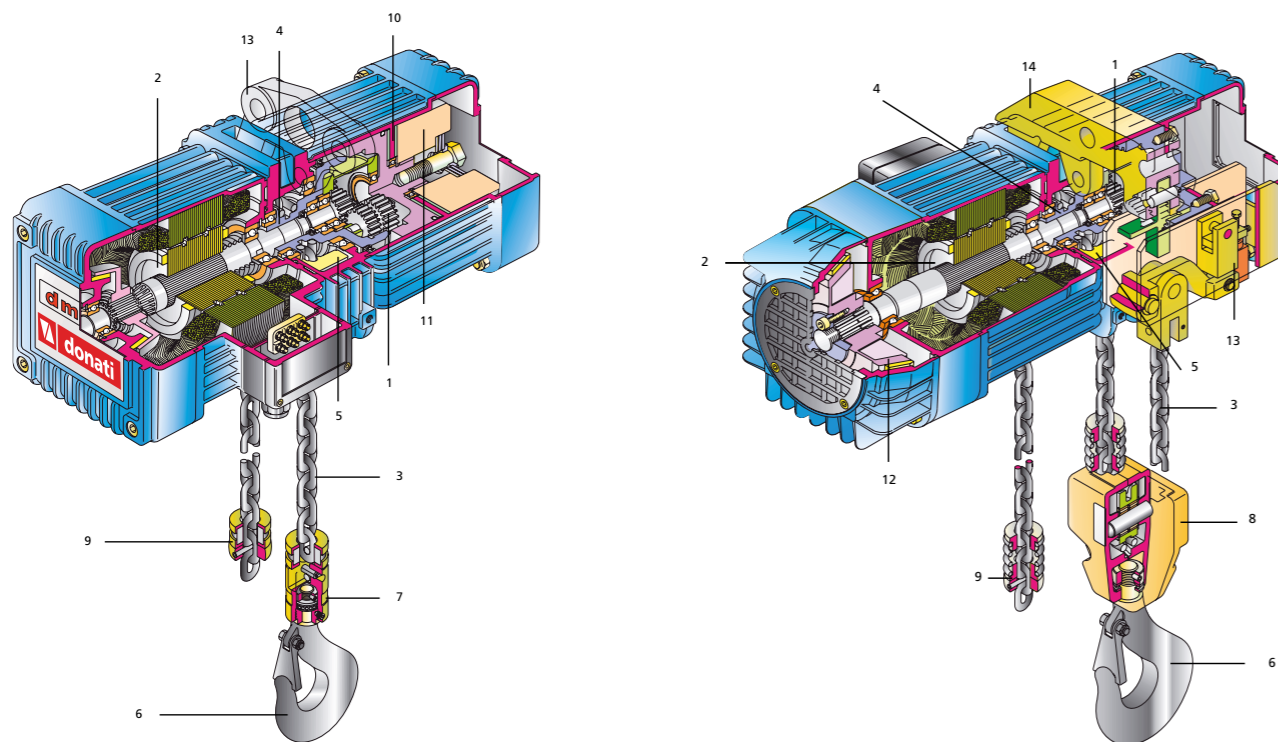

1 CHAIN FALL UP TO 2000 kg

This is a winning technical solution that offers:

- ▶ more compact design and greater hook run since the bottom block has smaller dimensions compared to a hook block and the chain box is smaller;
- ▶ greater safety for the operator who can touch the hook and chain without the risk of being dragged in and crushed;
- ▶ greater reliability, less maintenance and lower operating costs since jamming cannot occur, the chain is not worn by the return and there are no moving parts to replace in the bottom block;
- ▶ greater use flexibility.

2 CHAIN FALLS OVER 2000 kg

This solution is aimed at the affordability of the entire system which: offers a fixed anchoring point on which to apply a sensitive load limiter that is suitable for heavy-duty applications and does not require useless overdimensioning of the weight-bearing structure; keeping the dimensions and the cost of the chain contained.

1. GEARBOX

Epicyclic reduction gear with thermally treated, high resistance steel wheels, supported on ball bearings and lubricated in oil bath. The frame is a radiating fin structure in aluminium alloy to improve heat dissipation.

2. SELF-BRAKING ELECTRIC MOTOR

The axial movement of the conical brake allows fast, reliable mechanical braking over time [RES. 4.1.2.6. c - Annex I Machinery Directive]. The brake lining is asbestos free. Asynchronous three phase with single polarity for one speed hoists, with pole changing version for two speed hoists.

3. CHAIN

The chain is gauged and made of high-strength steel rod with excellent dynamic stability, ultimate tensile strength of 80 kg/mm² and ultimate elongation no higher than 10%. The applicable safety coefficient is always greater than 5 [RES. 4.1.2.4. - Annex I Machinery Directive]. The heat and galvanising treatments applied to the chain provide high resistance to wear, aging and corrosion.

4. LOAD SPROCKET

The load sprocket is heat treated and has five pockets mechanically machined on high precision automatic machinery. The sprocket drives the chain, ensuring perfect chain movement.

5. CHAIN GUIDE (INSERTER/EXTRACTOR)

The chain guide is used to insert and extract the chain links both in and out of the pockets, both when lifting and lowering [RES. 4.1.2.4. Annex I Machinery Directive].

6. LOAD HOOK

The hook is made from high strength steel and is equipped with a safety device (spring catch) to prevent the load from unhooking [RES. 4.1.2.6. e - Annex 1 Machinery Directive] and rotates on a thrust bearing.

7. BOTTOM BLOCK (ONE CHAIN FALL HOISTS)

This connects the chain to the turning hook. It is made of steel and is equipped with a heat-treated large cross-section pin to lock the chain.

8. HOOK BLOCK (2 CHAIN FALL HOISTS)

Made of cast aluminium, completely closed, it is fitted with a high resistance steel transmission reel that is thermally treated and has pockets for housing the chain.

9. CHAIN STOPS

The stops are installed on the free descending and ascending sections of the chain on one fall hoists. They act as limit switches for hoist travel [RES. 4.1.2.6.a - Annex I Machinery Directive]; they are made of forged steel and are fitted with a shock-absorbing insert.

CHAIN BOX

The chain box is used to hold the descending section of the chain. It is available in different sizes based on the hook travel. It is made of shock-resistant plastic and is equipped with suspensions to allow free movement.

10. CLUTCH DEVICE (ONE CHAIN FALL HOISTS)

This is an emergency device, an up and down limit switch. It also acts as an overload protection [RES. 4.2.1.4. Annex I Machinery Directive]. The clutch discs are asbestos free and are preloaded with a Belleville washer system.

11. BALANCER (ONE CHAIN FALL HOISTS)

The balancer is connected to the clutch device and ensures hoist balancing. It absorbs the heat generated during clutch movement.

12. DMK 2-3-4 BRAKE

The brake shoe installed on sizes 2-3 and 4 is made with a fan which ensures cooling of the brake and the motor. The high degree of inclination of the braking surface allows perfect unlocking of the brake even in the most difficult working conditions.

Brake adjustment is easily performed since it can be done from the outside using the adjusting ring.

13. OVERLOAD DEVICE (TWO CHAIN FALL HOISTS)

Electromechanical with a microswitch for one intervention threshold [RES. 4.2.1.4 - Annex I Machinery Directive]. The overload device does not allow the hoist to be loaded with an overload exceeding 20% of its maximum capacity, by blocking the lifting control circuit.

LIFTING LIMIT SWITCHES

Standard equipment for 2 chain fall hoists and available upon request for 1 chain fall hoists. They limit the hook's ascent and descent runs [RES. 4.1.2.6 a) - Annex I Machinery Directive]. They are composed of two precision microswitches which function according to the "slow positive opening" principle and work on the auxiliary circuit of the lifting motor control device.

14. SUSPENSION

It is produced with an eyebolt fitting; it can be made with a hook execution upon request or even a 90° eyebolt version for longitudinal hoist.

ELECTRICAL CONTROLS

When the hoist is supplied with electrical control, the movements can be activated, alternatively, by:

- ▶ **low voltage controls at AC 48V - 50Hz**, including: the transformer for the low voltage power supply of the control circuits, the general line contactor, the contactors for the control of the hoist and electric trolley motors, transformer protection fuses and terminal block for connections of the auxiliary and power circuits. The components are contained in a sealed box with IP 55 protection, made of shockproof thermoplastic material. The equipment is installed on the motor side of the hoist.
- ▶ **direct control**, direct control with mains voltage, solely available for the control of the electric hoist, for raise and lower functions. It is composed by a pushbutton panel that interrupts and directly switches the power line.

In both options, the controls are activated by the hanging pushbutton panel, with ergonomic shape, made of self-extinguishing, shockproof, waterproof, thermoplastic material, with IP 65 protection. The emergency stop function [RES. 1.2.4 - Annex I Machinery Directive], is produced with a mushroom-head button which, using an intentional release action, puts the control circuit in forward position [RES. 1.2.3 Annex I Machinery Directive]. The hanging push button pendant is connected to the hoist by a multipolar electrical cable supported by tear proof metallic parts.

DMT TROLLEYS

used to horizontally move the load. They are manufactured in three difference versions: **SM** type, hand-pushed; **CM** type, mechanically-operated chain and **EM** type, electrically-operated. They move on the lower flange of the beam and can be adjusted based on the flange width.

They are made of pressed steel plate (GR 2) and in pantographed sheet (GR3, 4 and 5) have anti-derail brackets [RES. 4.1.2.2. Annex I Machinery Directive] and shock-absorbing buffers.

The trolleys are equipped with forged steel machined wheels rotating on permanently lubricated ball bearings.

Gear motor with self-braking motor: provides motion to the trolley toothed wheels in the electric version, EM type [RES. 4.1.2.6. c - Annex I Machinery Directive].

Limit switch: these switches limit horizontal travel of the electric trolley on the beam [RES. 4.1.2.6. a – Annex I Machinery Directive].

Towing arm: the towing arm, which connects the trolley to the power supply, is available for all types of trolleys of the DMT series. It can be easily adjusted in all directions and is an essential part for towing the power cable without tearing the conductors.

STANDARDS AND CERTIFICATIONS

DESIGN AND CONSTRUCTION

DMK electric chain hoists and their trolleys are designed and manufactured according to the **“Essential Safety Requirements” of Annex I of Machinery Directive 2006/42/EC** and are placed on the market **equipped with the CE mark and CE Declaration of Conformity - Annex II A.**

In addition DMK electric chain hoists and their trolleys are in compliance with the following directives:

- ▶ **LOW VOLTAGE DIRECTIVE 2014/35/UE**
- ▶ **ELECTROMAGNETIC COMPATIBILITY DIRECTIVE 2014/30/UE**

DMK series electric chain hoists and their trolleys are also available with CSA homologation, upon request.

REFERENCE NORMATIVE FRAMEWORK

The design and construction of DMK series electric chain hoists and their trolleys comply with the following technical standards and rules:

- ▶ EN ISO 1210:2010 “Fundamental concepts, general design principles”
- ▶ EN ISO 13849-1:2008 “Safety-related parts of control systems (where required)”
- ▶ EN 12077-2:2008 “Limiting and indicating devices”
- ▶ EN 60204-32:2009 “Safety of the electrical equipment of lifting machines”
- ▶ EN 60529:1997 “IP enclosure (IP Codes)”
- ▶ ISO 4301-1:1988 “Classification of lifting equipment”
- ▶ DIN 15401 “Choice of lifting hooks”
- ▶ FEM 1.001/98 “Rules for the design of lifting equipment”
- ▶ FEM 9.511/86 “Mechanisms classification”
- ▶ FEM 9.671/88 “Quality of chains”
- ▶ FEM 9.683/95 “Choice of lifting and traverse motors”
- ▶ FEM 9.755/93 “Periods of safe work”
- ▶ FEM 9.941/95 “Control symbols”



CRITERIA OF USE AND OPERATING LIMITS

It is necessary to check the parameters which characterise the operating limits of the DMK electric chain hoists to be able to have a complete correspondence between the DMK electric chain hoists and the service they were designed for. These are the actual lifting capacities, which must always be less than or equal with respect to the nominal capacity of the hoist state of stress and average duration of daily operation.

ACTUAL LIFTING CAPACITY

This is determined by the heaviest load to be lifted.

The nominal lifting capacity of the hoist must be \geq the actual lifting capacity.
Lifting capacity = kg



THE STATE OF STRESS

The state of stress is evaluated considering the actual entity of the loads to be lifted and it is ascribable to one of four spectrums of load shown below which determine the type of service.

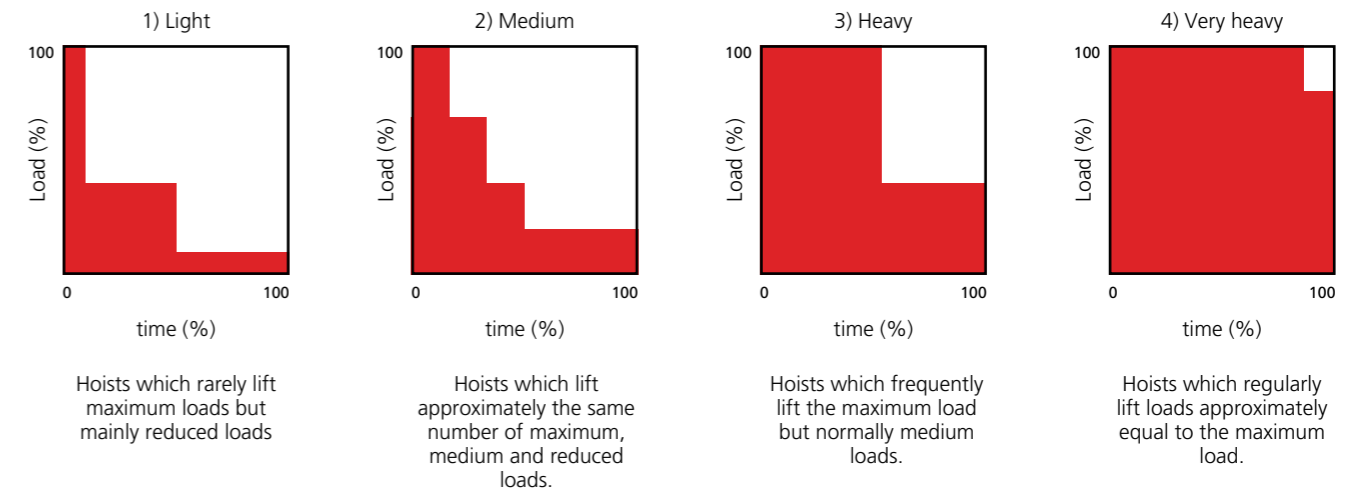

AVERAGE DURATION OF DAILY OPERATION

For LIFTING operations the average duration of operation is calculated as follows: $T_m \text{ (hours)} = (C_e \times C/h \times T_i) / (30 \times V)$

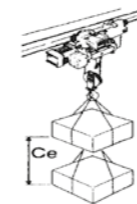

Actual hook run
 $C_e = m$

It is the average of the actual runs of the load

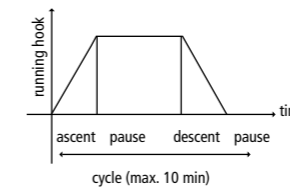

Cycles in an hour
 $C/h = N^\circ$

It is the number of complete ascents and descents carried out in an hour.



Running time
 $T_i = \text{hours}$

Hoist running time in a whole day.

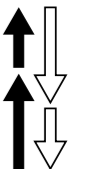

Lifting speed
 $V = m/min$

It is the distance covered by the load in a minute.

OPERATING LIMITS OF DMK HOISTS IN RELATION TO THE SERVICE GROUPS OF THE MECHANISMS, ACCORDING TO FEM 9.511/86 (ISO 4301-1:1988)

GROUP FEM (ISO)	AVERAGE DURATION OF DAILY OPERATION - $T_m = \text{HOURS}$; WITH LOAD				INTERMITTENCE RATIO %	N° OF STARTS PER HOUR	N° OF CYCLES PER HOUR
	1) LIGHT	2) MEDIUM	3) HEAVY	4) VERY HEAVY			
1Bm(M3)	2	1	0,5	0,25	RI = 25%	A/h = 150	C/h = 25
1Am(M4)	4	2	1	0,5	RI = 30%	A/h = 180	C/h = 30
2m(M5)	8	4	2	1	RI = 40%	A/h = 240	C/h = 40

TECHNICAL SPECIFICATIONS AND DATA FOR DMK CHAIN HOISTS WITH DMT TROLLEYS

CHARACTERISTIC DATA FOR DMK SERIES ELECTRIC CHAIN HOISTS AND DMT TROLLEYS

CAPACITY (kg)	FEM GROUP	DMK TYPE	CHAIN FALLS	LIFTING SPEED (m/min)		LIFTING MOTOR POWER (kW)		DMT TROLLEY TYPE FOR HOIST S= MANUAL-PUSH TROLLEY C= MANUAL GEAR OPERATED TROLLEY E=ELECTRIC TROLLEY					TROLLEY MOTOR POWER (kW)				CHAIN TYPE	CHAIN WEIGHT PER METER (kg/m)	
				1 SPE.	2 SPE.	1 SPE.	2 SPE.	S	C	E SPEED (m/min)				SPEED (m/min)					
										11	14	22	7/22	11	14	22			7/22
125	2m	154C	1	8	/	0.2	/	SM2	CM3	EM3	EM3	EM3	EM3	0.12	0.18	0.25	0.08/0.25	4x12	0.38
	2m	132D	1	8	2.5	0.2	0.06	SM2	CM3	EM3	EM3	EM3	EM3	0.12	0.18	0.25	0.08/0.25	4x12	0.38
	2m	232C	1	16	/	0.4	/	SM2	CM3	EM3	EM3	EM3	EM3	0.12	0.18	0.25	0.08/0.25	5x15	0.58
250	2m	134C	1	4	/	0.2	/	SM2	CM3	EM3	EM3	EM3	EM3	0.12	0.18	0.25	0.08/0.25	4x12	0.38
	2m	112D	1	4	1.2	0.2	0.06	SM2	CM3	EM3	EM3	EM3	EM3	0.12	0.18	0.25	0.08/0.25	4x12	0.38
	2m	234C	1	8	/	0.4	/	SM2	CM3	EM3	EM3	EM3	EM3	0.12	0.18	0.25	0.08/0.25	5x15	0.58
	2m	234D	1	8	2.5	0.4	0.12	SM2	CM3	EM3	EM3	EM3	EM3	0.12	0.18	0.25	0.08/0.25	5x15	0.58
500	2m	332C	1	16	/	0.8	/	SM3	CM3	EM3	EM3	EM3	EM3	0.12	0.18	0.25	0.08/0.25	7x21	1.16
	2m	214C	1	4	/	0.4	/	SM2	CM3	EM3	EM3	EM3	EM3	0.12	0.18	0.25	0.08/0.25	5x15	0.58
	2m	214D	1	4	1.2	0.4	0.12	SM2	CM3	EM3	EM3	EM3	EM3	0.12	0.18	0.25	0.08/0.25	5x15	0.58
	2m	334C	1	8	/	0.8	/	SM3	CM3	EM3	EM3	EM3	EM3	0.12	0.18	0.25	0.08/0.25	7x21	1.16
	2m	334D	1	8	2.5	0.8	0.24	SM3	CM3	EM3	EM3	EM3	EM3	0.12	0.18	0.25	0.08/0.25	7x21	1.16
	2m	432C	1	16	/	1.6	/	SM4	CM4	EM4	EM4	EM4	EM4	0.12	0.18	0.25	0.08/0.25	10x28	2.42
1000	2m	314C	1	4	/	0.8	/	SM3	CM3	EM3	EM3	EM3	EM3	0.12	0.18	0.25	0.08/0.25	7x21	1.16
	2m	314D	1	4	1.2	0.8	0.24	SM3	CM3	EM3	EM3	EM3	EM3	0.12	0.18	0.25	0.08/0.25	7x21	1.16
	2m	434C	1	8	/	1.6	/	SM4	CM4	EM4	EM4	EM4	EM4	0.12	0.18	0.25	0.08/0.25	10x28	2.42
	2m	434D	1	8	2.5	1.6	0.5	SM4	CM4	EM4	EM4	EM4	EM4	0.12	0.18	0.25	0.08/0.25	10x28	2.42
1600	2m	424L	1	6.3	/	2.5	/	SM4	CM4	EM4	EM4	EM4	EM4	0.12	0.18	0.25	0.08/0.25	10x28	2.42
	2m	424D	1	6.3	2.1	2	0.65	SM4	CM4	EM4	EM4	EM4	EM4	0.12	0.18	0.25	0.08/0.25	10x28	2.42
2000	2m	414C	1	4	/	1.6	/	SM4	CM4	EM4	EM4	EM4	EM4	0.12	0.18	0.25	0.08/0.25	10x28	2.42
	2m	414D	1	4	1.2	1.6	0.5	SM4	CM4	EM4	EM4	EM4	EM4	0.12	0.18	0.25	0.08/0.25	10x28	2.42
2500	2m	434L.I	2	4	/	2.5	/	SM5	CM5	EM5	EM5	EM5	EM5	0.17	0.25	0.37	0.08/0.25	10x28	2.42
	2m	424D.I	2	3.2	1	2	0.65	SM5	CM5	EM5	EM5	EM5	EM5	0.17	0.25	0.37	0.08/0.25	10x28	2.42
3200	1Am	434L.J	2	4	/	2.5	/	SM5	CM5	EM5	EM5	EM5	EM5	0.17	0.25	0.37	0.08/0.25	10x28	2.42
	1Am	424D.J	2	3.2	1	2	0.65	SM5	CM5	EM5	EM5	EM5	EM5	0.17	0.25	0.37	0.08/0.25	10x28	2.42
	2m	424L.J	2	3.2	/	2.5	/	SM5	CM5	EM5	EM5	EM5	EM5	0.17	0.25	0.37	0.08/0.25	10x28	2.42
	2m	454D.J	2	2.5	0.8	2	0.65	SM5	CM5	EM5	EM5	EM5	EM5	0.17	0.25	0.37	0.08/0.25	10x28	2.42
4000	1Am	424L.K	2	3.2	/	2.5	/	SM5	CM5	EM5	EM5	EM5	EM5	0.17	0.25	0.37	0.08/0.25	10x28	2.42
	1Am	454D.K	2	2.5	0.8	2	0.65	SM5	CM5	EM5	EM5	EM5	EM5	0.17	0.25	0.37	0.08/0.25	10x28	2.42

SINGLE-PHASE VERSION

CAPACITY (kg)	FEM GROUP	DMK TYPE	CHAIN FALLS	LIFTING SPEED (m/min)		LIFTING MOTOR POWER (kW)		DMT TROLLEY TYPE FOR HOIST S= MANUAL-PUSH TROLLEY C= MANUAL GEAR OPERATED TROLLEY		CHAIN TYPE	CHAIN WEIGHT PER METER (kg/m)
				1 SPE.	2 SPE.	1 SPE.	2 SPE.	S	C		
100	1Bm	132M	1	8	/	0.2	/	SM2	CM3	4x12	0.38
200	1Bm	112M	1	4	/	0.2	/	SM2	CM3	4x12	0.38
	1Bm	234M	1	8	/	0.4	/	SM2	CM3	5x15	0.58
400	1Bm	214M	1	4	/	0.4	/	SM2	CM3	5x15	0.58
	1Bm	334M	1	8	/	0.8	/	SM3	CM3	7x21	1.16
800	1Bm	314M	1	4	/	0.8	/	SM3	CM3	7x21	1.16

DMK ELECTRIC CHAIN HOISTS – OVERALL DIMENSIONS WEIGHTS – FIXED EXECUTION

1 chain fall version

2 chain falls version

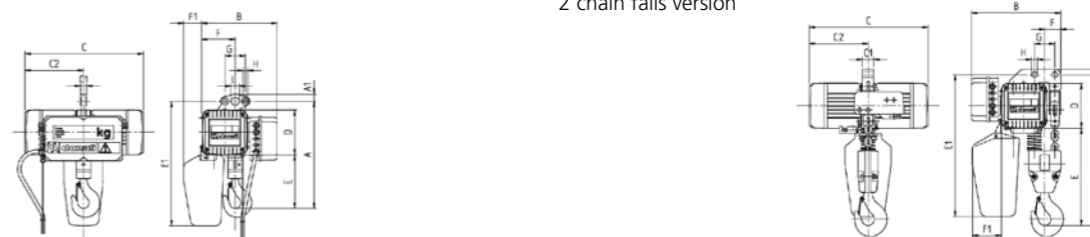

SIZE	CHAIN FALLS	DMK TYPE	*HOIST WEIGHT (kg)	OVERALL DIMENSIONS (mm)											
				**A	A1	B	C	C1	C2	D	**E	F	G	H	I
1	1	154C	23	275	23	253	385	19	207	120	128	80	70	14	27
	1	132D/M	23	275	23	253	385	19	207	120	128	80	70	14	27
	1	134C	23	275	23	253	385	19	207	120	128	80	70	14	27
	1	112D/M	23	275	23	253	385	19	207	120	128	80	70	14	27
2	1	232C	33	310	23	268	438	19	237	135	150	92	70	14	27
	1	234C/M	33	310	23	268	438	19	237	135	150	92	70	14	27
	1	234D	33	310	23	268	438	19	237	135	150	92	70	14	27
	1	214C/M	33	310	23	268	438	19	237	135	150	92	70	14	27
3	1	214D	33	310	23	268	438	19	237	135	150	92	70	14	27
	1	332C	50	378	28	293	514	25	274	160	188	114	70	14	30
	1	334C/M	50	378	28	293	514	25	274	160	188	114	70	14	30
	1	334D	50	378	28	293	514	25	274	160	188	114	70	14	30
4	1	314C/M	50	378	28	293	514	25	274	160	188	114	70	14	30
	1	314D	50	378	28	293	514	25	274	160	188	114	70	14	30
	1	432C	80	471	32	332	583	27	317	200	233	146	90	20	35
	1	434C	80	471	32	332	583	27	317	200	233	146	90	20	35
	1	434D	80	471	32	332	583	27	317	200	233	146	90	20	35
	1	424L	80	471	32	332	583	27	317	200	233	146	90	20	35
	1	414C	80	471	32	332	583	27	317	200	233	146	90	20	35
	1	414D	80	471	32	332	583	27	317	200	233	146	90	20	35
	2	434L.I	105	670	25	395	583	50	317	200	432	71	90	25	/
	2	424D.I	105	670	25	395	583	50	317	200	432	71	90	25	/
4	2	434L.J	105	670	25	395	583	50	317	200	432	71	90	25	/
	2	424D.J	105	670	25	395	583	50	317	200	432	71	90	25	/
	2	424L.J	105	670	25	395	583	50	317	200	432	71	90	25	/
	2	454D.J	105	670	25	395	583	50	317	200	432	71	90	25	/
	2	424L.K	105	670	25	395	583	50	317	200	432	71	90	25	/
	2	454D.K	105	670	25	395	583	50	317	200	432	71	90	25	/

* Weight of hoist with 3m hook run and 2m push button panel cable
 ** With application of raise/lower electric limit switches A and E dimensions increase by: DMK1 + 45mm; DMK2 + 40mm; DMK3 + 45mm; DMK4 (1 fall) + 60mm

CHAIN BOX TYPE (C-D-E-F-G-H-I)

SIZE	CHAIN FALLS	C	D	E	F	G	H	I	
1	1	Max hook run (m)	5	8	13	20	32	70	115
	1	E1	347	372	397	427	467	522	607
	1	F1	47	63	77	100	120	150	200
2	1	Max hook run (m)	/	4	7	12	18	30	70
	1	E1	/	385	410	440	480	535	620
	1	F1	/	56	70	92	112	142	192
3	1	Max hook run (m)	/	/	3	5	9	16	25
	1	E1	/	/	440	470	510	560	650
	1	F1	/	/	55	77	97	127	177
4	1	Max hook run (m)	/	/	/	/	4	8	13
	1	E1	/	/	/	/	560	610	700
	1	F1	/	/	/	/	80	110	160
	2	Max hook run (m)	/	/	/	/	/	3	5
	2	E1	/	/	/	/	/	628	718
	2	F1	/	/	/	/	/	130	180

NOTE With application of raise/lower limit switches on 1 chain fall hoists, the maximum capacity of the chain box decreases by 1 m of hook run and the E1 dimension increases by 25 mm.

DMK ELECTRIC CHAIN HOISTS WITH DMT TROLLEYS

OVERALL DIMENSIONS – WEIGHTS

Hoist with SM hand-push trolley

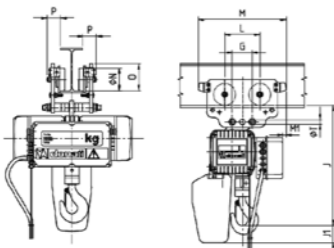

Hoist with EM electric trolley

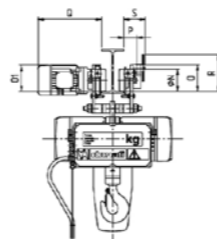

Hoist with CM manual gear operated trolley

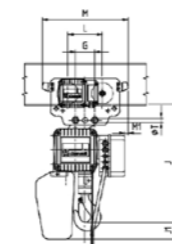
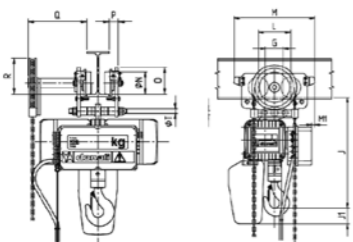

1 chain fall version

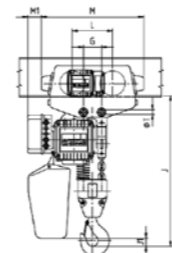

2 chain falls version

DMK SIZE	CHAIN FALLS	DMT TROLLEY TYPE	*HOIST TROLLEY WEIGHT (kg)	OVERALL DIMENSIONS (mm)												
				***J	L	M	M1	Ø N	O	**O1	P	**Q	R	S	Ø T	
1	1	SM2	29	323	100	236	54	52	72	/	20	/	/	/	M16	
	1	EM3	58	345	135	362	-10	80	98	100(108)	54	290(314)	165	90	M14	
	1	CM3	41	345	135	362	-10	80	98	/	54	240	108	/	M14	
2	1	SM2	39	360	100	236	58	52	72	/	20	/	/	/	M16	
	1	EM3	68	380	135	362	-6	80	98	100(108)	54	290(314)	165	90	M14	
	1	CM3	51	380	135	362	-6	80	98	/	54	240	108	/	M14	
3	1	SM3	62	448	135	362	-3	80	98	/	54	/	/	/	M14	
	1	EM3	85	448	135	362	-3	80	98	100(108)	54	290(314)	165	90	M14	
	1	CM3	68	448	135	362	-3	80	98	/	54	240	108	/	M14	
4	1	SM4	105	547	160	402	-15	100	120	/	60	/	/	/	M20	
	1	EM4	130	547	160	402	-15	100	120	110(118)	60	296(320)	165	96	M20	
	1	CM4	115	547	165	402	-15	100	120	/	60	264	160	/	M20	
	2	SM5	160	755	201	510	70	125	155	/	55	/	/	/	M24	
	2	EM5	190	755	201	510	70	125	155	130(130)	55	316(316)	211	110	M24	
	2	CM5	170	755	201	510	70	125	155	/	55	350	198	/	M24	

* Weight referred to 3m hook-run hoist.

** Dimensions for 2 speed trolleys in brackets.

*** SM3/EM3/CM3: for width > 220 mm up to 400 mm dimension J increases by 70 mm

*** SM4/EM4/CM4: for width > 220 mm up to 400 mm dimension J increases by 60 mm

*** SM5/EM5/CM5: for width > 220 mm up to 400 mm dimension J increases by 75 mm

Note When the hoist is equipped with raise/lower limit switches, dimension J increases as much as dimensions A and E, page 11 and note regarding the chain box

MAXIMUM REACTIONS OF DMT TROLLEY WHEELS ON BEAM FLANGE

DMK SIZE	MAX CAPACITY (kg)	DMT TROLLEY TYPE	OVERALL DIMENSIONS (mm)				
			Ø R	I	B	*R MAX (kg)	SP MAX
1	250	SM2	52	5	15	80	17
		EM3/CM3	80	7	16	87	22
2	500	SM2	52	5	15	154	17
		EM3/CM3	80	7	16	161	22
3	1000	SM3					
		EM3/CM3	80	7	16	309	22
4	2000	SM4					
		EM4/CM4	100	9	19	608	24
	4000	SM5					
		EM5/CM5	125	14	29	1193	20

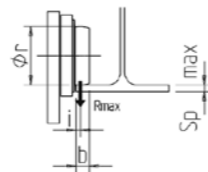

* Max R calculated with a dynamic coefficient of 1.15 and no "M" increasing coefficient

DMK ELECTRIC CHAIN HOISTS LOW HEAD ROOM EXECUTION

OVERALL DIMENSIONS – WEIGHTS

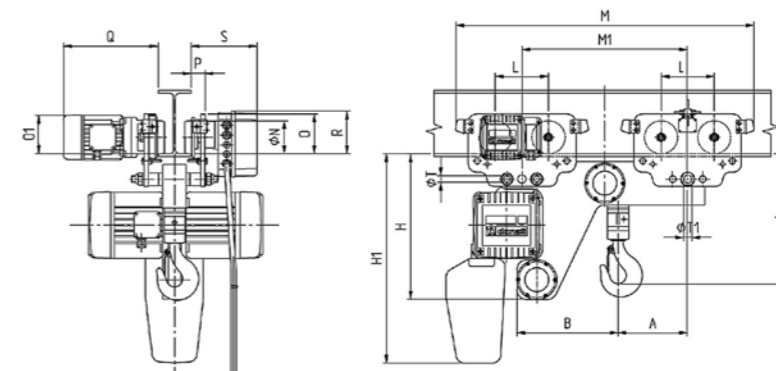

DMK SIZE	MAX CAPACITY (kg)	DMT TROLLEY TYPE	*HOIST TROLLEY WEIGHT (kg)	OVERALL DIMENSIONS (mm)																
				A	B	H	***H1	J	L	M	M1	Ø N	O	**O1	P	**Q	R	S	Ø T	Ø T1
1	250	SM3+SM3	60	170	228	295	417	233	135	742	380	80	98	/	54	/	108	/	M14	M16
		SM3+EM3	75	170	228	295	417	233	135	742	380	80	98	100/(108)	54	290/(314)	108	196	M14	M16
2	500	SM3+SM3	67	176	240	315	455	255	135	762	386	80	98	/	54	/	108	/	M14	M16
		SM3+EM3	80	176	240	315	455	255	135	762	386	80	98	100/(108)	54	290/(314)	108	196	M14	M16
3	1000	SM3+SM3	100	190	275	365	510	313	135	812	450	80	98	/	54	/	108	/	M14	M16
		SM3+EM3	115	190	275	365	510	313	135	812	450	80	98	100/(108)	54	290/(314)	108	196	M14	M16
4	2000	SM4+SM4	155	205	310	440	637	386	160	902	500	100	120	/	60	/	118	/	M20	M24
		SM4+EM4	170	205	310	440	637	386	160	902	500	100	120	110/(118)	60	296/(320)	118	202	M20	M24
	4000	UPON REQUEST	/	/	/	/	/	/	/	/	/	/	/	/	/	/	/	/	/	/
		UPON REQUEST	/	/	/	/	/	/	/	/	/	/	/	/	/	/	/	/	/	/

* Weight referred to 3m hook-run hoist.

** Dimensions for 2 speed trolleys in brackets

*** Weight referred to 3m hook-run hoist

With application of an electric raise/lower limit switch dimension H1 increases by 25mm and dimension J increases by: DMK1+45mm; DMK2+40mm; DMK3+45mm; DMK4(1 fall)+60mm

MAXIMUM REACTIONS OF DMT TROLLEY WHEELS ON BEAM FLANGE FOR DMK LOW HEAD ROOM EXECUTION

DMK SIZE	MAX CAPACITY (kg)	DMT TROLLEY TYPE	OVERALL DIMENSIONS (mm)				
			Ø R	I	B	*R MAX (kg)	SP MAX
1	250	SM3+SM3				44	
		SM3+EM3	80	7	16	87	18
2	500	SM3+SM3				80	
		SM3+EM3	80	7	16	82	18
3	1000	SM3+SM3				156	
		SM3+EM3	80	7	16	158	18
4	2000	SM4+SM4				307	
		SM4+EM4	100	9	19	608	21
	4000	SM5+EM5 (UPON REQUEST)				/	/
		SM5+EM5 (UPON REQUEST)	125	14	29	/	/

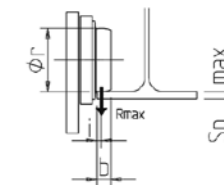

* Max R calculated with a dynamic coefficient of 1.15 and no "M" increasing coefficient

TECHNICAL SPECIFICATIONS AND DATA FOR DMK HOIST CHAIN CLIMBING EXECUTION

CAPACITY (kg)	FEM GROUP	DMK TYPE	CHAIN FALLS	LIFTING SPEED (mm)		LIFTING MOTOR POWER (kW)		*HOIST WEIGHT (kg)	CHAIN TYPE	CHAIN WEIGHT PER METER (kg/m)
				1 SPEED	2 SPEED	1 SPEED	2 SPEED			
125	2m	154C	1	8	/	0.2	/	17	4x12	0.38
250	2m	134C	1	4	/	0.2	/	17	4x12	0.38
	2m	234C	1	8	/	0.4	/	24	5x15	0.58
500	2m	214C	1	4	/	0.4	/	24	5x15	0.58
	2m	334C	1	8	/	0.8	/	38	7x21	1.16
1000	2m	314C	1	4	/	0.8	/	38	7x21	1.16
	2m	434C	1	8	/	1.6	/	65	10x28	2.42
2000	2m	414C	1	4	/	1.6	/	65	10x28	2.42

* Hoist weight without chain

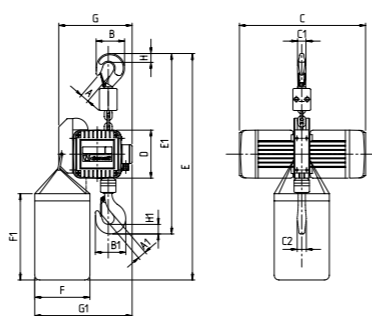

CLIMBING VERSION

OVERALL DIMENSIONS - WEIGHTS

DMK SIZE	MAX CAPACITY (kg)	DMK HOIST TYPE	OVERALL DIMENSIONS (mm)															
			A	A1	B	B1	C	C1	C2	D	E	E1	F	F1	G	G1	H	H1
1	125	154C	21	24	62	67	385	22	19	120	710	400	230	360	210	310	17	19
	250	134C	21	24	62	67	385	22	19	120	710	400	230	360	210	310	17	19
2	250	234C	25	28	78	83	438	22	23	135	740	465	230	360	225	325	22	24
	500	214C	25	28	78	83	438	22	23	135	740	465	230	360	225	325	22	24
3	500	334C	30	34	96	103	514	27	30	160	800	577	230	360	250	350	29	32
	1000	314C	30	34	96	103	514	27	30	160	800	577	230	360	250	350	29	32
4	1000	434C	36	40	118	137	583	35	38	200	880	716	230	360	307	410	37	44
	2000	414C	36	40	118	137	583	35	38	200	880	716	230	360	307	410	37	44

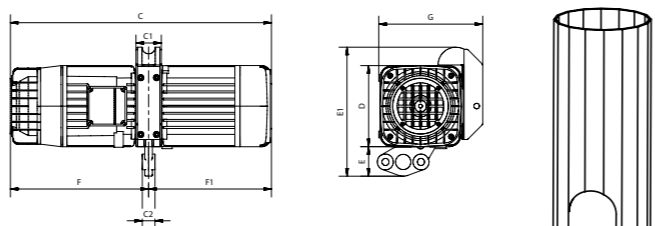

TOWER VERSION

OVERALL DIMENSIONS - WEIGHTS

DMK SIZE	MAX CAPACITY (kg)	DMK HOIST TYPE	OVERALL DIMENSIONS (mm)								
			C	C1	C2	D	E	E1	F	F1	G
1	125	154C	385	40	19	120	49	202	178	177	157
	250	134C	385	40	19	120	49	202	178	177	157
2	250	234C	438	44	19	135	48	217	201	237	172
	500	214C	438	44	19	135	48	217	201	237	172
3	500	334C	514	50	25	160	58	252	240	274	197
	1000	314C	514	50	25	160	58	252	240	274	197
4	1000	434C	583	65	27	200	70	319	266	347	255
	2000	414C	583	65	27	200	70	319	266	347	255

Suitable for incorporation into metal poles used for lighting. For assembly and maintenance, relevant chain return allows a mobile crown, fitted with lights, to be lifted and lowered along the pole itself. In order to guarantee excellent operation, the hoist is assembled in an inverted position with respect to standard applications.

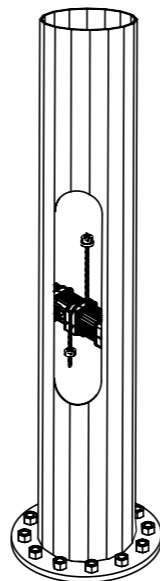

SPECIFICATIONS OF MOTORS, FUSES AND POWER CABLES

TROLLEY TYPE	BEAM TYPE	GROUP 1		GROUP 2		GROUP 3		GROUP 4		*MINIMUM RADIUS OF MONORAIL INTERNAL CURVATURE (mm)
		BEAM	FLANGE	BEAM	FLANGE	BEAM	FLANGE	BEAM	FLANGE	
SM2	INP	80÷160	42÷74	180÷280	82÷119	300÷380	125÷149	400	155	1000
	IPE	80÷140	46÷73	160÷240	82÷120	270÷300	135÷150	330÷500	160÷200	
SM3	HEA	-	-	100÷120	100÷120	140	140	160÷200	160÷200	1300
	INP	120÷240	58÷106	260÷450	113÷170	475÷600	178÷215	-	-	
	IPE	120÷220	64÷110	240÷360	120÷170	400÷600	180÷220	-	-	
SM4	HEA	-	-	140÷160	140÷160	180÷220	180÷220	-	-	1500
	INP	160÷280	74÷119	300÷475	125÷178	500÷600	185÷215	-	-	
	IPE	160÷240	82÷120	270÷400	135÷180	450÷600	190÷220	-	-	
SM5	HEA	-	-	160÷180	160÷180	200÷220	200÷220	-	-	1900
	INP	180÷300	82÷125	320÷500	131÷185	550÷600	200÷215	-	-	
	IPE	180÷240	91÷120	270÷400	135÷180	450÷600	190÷220	-	-	
CM3	HEA	-	-	180	180	200÷240	200÷240	-	-	1300
	INP	140÷240	66÷106	260÷450	113÷170	475÷600	178÷215	-	-	
	IPE	140÷220	73÷110	240÷360	120÷170	400÷600	180÷220	-	-	
CM4	HEA	-	-	140÷160	140÷160	180÷220	180÷220	-	-	1500
	INP	180÷280	82÷119	300÷475	125÷178	500÷600	185÷215	-	-	
	IPE	180÷240	91÷120	270÷400	135÷180	450÷600	190÷220	-	-	
CM5	HEA	-	-	160÷180	160÷180	200÷220	200÷220	-	-	1900
	INP	220÷300	98÷125	320÷500	131÷185	550÷600	200÷215	-	-	
	IPE	220÷240	110÷120	270÷400	135÷180	450÷600	190÷220	-	-	
EM3	HEA	-	-	180	180	200÷240	200÷240	-	-	1300
	INP	120÷240	58÷106	260÷450	113÷170	475÷600	178÷215	-	-	
	IPE	120÷220	64÷110	240÷360	120÷170	400÷600	180÷220	-	-	
EM4	HEA	-	-	140÷160	140÷160	180÷220	180÷220	-	-	1500
	INP	160÷280	74÷119	300÷475	125÷178	500÷600	185÷215	-	-	
	IPE	160÷240	82÷120	270÷400	135÷180	450÷600	190÷220	-	-	
EM5	HEA	-	-	160÷180	160÷180	200÷220	200÷220	-	-	1900
	INP	180÷300	82÷125	320÷500	131÷185	550÷600	200÷215	-	-	
	IPE	180÷240	91÷120	270÷400	135÷180	450÷600	190÷220	-	-	

NOTE: For EM trolleys with electric travel limit switches, check the R dimensions on page 12
* Electric trolleys suitable to run on a bend with guide roller kit

SPECIFICATIONS OF MOTORS, FUSES AND POWER CABLES

HOIST TYPE	MOTOR TYPE	POLES	POWER (kW)	POWER FACTOR COSφ	Ia 50Hz		(In) 50	FUSES aM	POWER CABLE SECTION 400V - (ΔU20V)	
					380V A	400V A			Φmm²	L =m
134C-154C	71C4AS1/1	4	0.2	0.43	3.8		(1.4)	4	1.5	≤ 100
112D-132D	72K1AS1/1	2/6	0.2/0.06	0.6/0.5	3.3/1.8		(0.8/0.8)	4	1.5	≤ 100
232C	80C2AS2/2	2	0.4	0.45	6.5		(2.5)	4	1.5	≤ 100
214C-234C	80C4AS2/2	4	0.4	0.48	6.4		(2.1)	4	1.5	≤ 100
214D-234D	81K5AS2/2	4/12	0.4/0.12	0.6/0.6	5.2/3		(1.6/2)	4	1.5	≤ 100
332C	90C2AS3/2	2	0.8	0.6	14.5		(4.8)	6	1.5	≤ 70
314C-334C	90C4AS3/2	4	0.8	0.46	14		(5.2)	6	1.5	≤ 70
314D-334D	91K5AS3/3	4/12	0.8/0.24	0.6/0.5	14.6/4		(3.1/2.6)	6	1.5	≤ 70
432C	100C2AS4/2	2	1.6	0.7	32		(6.2)	10	2.5	≤ 50
414C-434C	100C4AS4/2	4	1.6	0.6	28		(6.5)	10	2.5	≤ 60
424L-434L	101K4AS4/2	4	2.5	0.7	38		(6.2)	10	2.5	≤ 40
414D-434D	101K5AS4/2	4/12	1.6/0.5	0.62/0.4	28/12		(5.5/6)	10	2.5	≤ 60
424D-454D	101K5AS4/4	4/12	2/0.65	0.72/0.5	28/8		(6.5/5)	10	2.5	≤ 60

SINGLE-PHASE HOIST	MOTOR TYPE	POLES	POWER (kW)	POWER FACTOR COSφ	Ia 50Hz		(In) 50	FUSES aM	POWER CABLE SECTION 230V - (ΔU20V)	
					230V A	230V A			Φmm²	L =m
132M-112M	72K2AM1/1	2	0.2	0.9	9.6		(3.2)	6	1.5	≤ 60
234M-214M	81K4AM2/1	4	0.4	0.9	11.3		(5.2)	10	1.5	≤ 50
334M-314M	91K4AM3/2	4	0.8	0.9	32		(12)	20	2.5	≤ 30

TROLLEY TYPE	MOTOR TYPE	POLES	POWER (kW)	POWER FACTOR COSφ	Ia - (A) 400V - 50HZ	In - (A) 400V - 50HZ
EM3-EM4	71C4TV1/1	4	0.25	0.43	3.8	1.4
EM3-EM4	71C8TS1/1	8	0.12	0.53	2.5	1.3
EM3-EM4	72K6TS1/1	6	0.18	0.5	3	1.7
EM3-EM4-EM5	81C5AD2/1	4/12	0.25/0.08	0.54/0.7	4.5/1.8	1.4/1.2
EM5	80C4TV2/1	4	0.37	0.7	4.4	1.7
EM5	80C8TS2/1	8	0.17	0.5	2.6	1.6
EM5	80C6TS2/1	6	0.25	0.5	3.8	1.2

DONATI WEBSITE

Donati's window on the world for customer service.

Manuals and product information

The new Donati website has been designed to assist customers to they can easily find all of the updated information on Donati products at any time. The Donati website makes it simple to consult and download product catalogues, technical manuals and product information sheets.



Donati Shop

The Donati Shop makes it possible to quickly and independently handle spare parts requests, thus reducing waiting times for customers.

Contact Section

The new contact section divided by departments lets you address your requests to the right team, so our staff can provide a faster and more accurate answer.

LEONARDO CONFIGURATION SYSTEM



Leonardo Configuration System is the Donati configurator system lets you configure and generate offers for Chain hoists, Jib cranes and Crane sets, easily and quickly; it lets you rapidly and efficiently respond to your customers' requests.

The suite is composed of two configurators:

Leonardo Product Configurator:

Used to configure chain hoists and jib cranes alone or in combination

Leonardo Crane Set Configurator:

Used to configure bridge cranes complete with all necessary accessories and Donati hoists.



visit donaticranes.com
and keep up to date

Donati Sollevamenti S.r.l.

Via S. Quasimodo, 17
20025 Legnano (MI) - Italy
Tel +39 0331 14811
Fax +39 0331 1481880

dvo.info@donaticranes.com
www.donaticranes.com